

Infrared Receiver Module IRM-37XXM3 Series

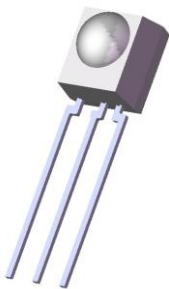

Pin Configuration

- 1: Vout
- 2: Vcc
- 3: GND

1 2 3

Block Diagram

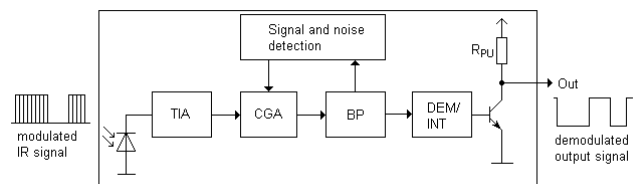

Features

- High protection ability against EMI
- Circular lens for improved reception characteristics
- Available for various carrier frequencies
- min burst length: 12 cycles
- min gap length: 16 cycles
- Low operating voltage and low power consumption
- High immunity against ambient light
- High immunity against TFT backlight
- Long reception range
- High sensitivity
- Pb free and RoHS compliant
- Compliance with EU REACH

Description

The IRM-37XXM3 devices are DIP type infrared receivers which have been developed and designed by using the latest IC technology.

The PIN diode and preamplifier are assembled onto a lead frame and molded into a black epoxy package which operates as an IR filter.

The demodulated output signal can directly be decoded by a microprocessor.

Applications

- AV equipment such as TV, VCR, DVD, CD, MD, etc.
- CATV set top boxes
- Multi-media Equipment
- Other devices using IR remote control

Application Circuit

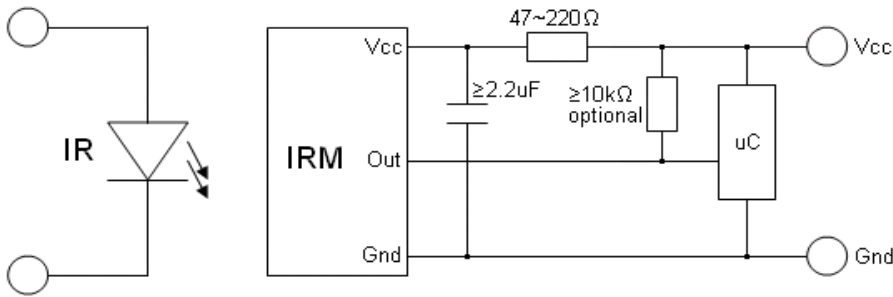

The RC Filter must be connected as close as possible to Vcc and GND pins.

Parts Number Table

Model No.	Carrier Frequency
IRM-3736M3	36 kHz
IRM-3738M3	38 kHz
IRM-3756M3	56 kHz

Absolute Maximum Ratings ($T_a=25^{\circ}\text{C}$)^{*1}

Parameter	Symbol	Rating	Unit
Supply Voltage	Vcc	6	V
Operating Temperature	Topr	-20 ~ +80	°C
Storage Temperature	Tstg	-40 ~ +85	°C
Soldering Temperature ^{*2}	Tsol	260	°C

^{*1} Stresses in excess of the absolute maximum ratings can cause permanent damage to the device. Functional operation of the device is not implied at these or any other conditions in excess of those given in the operational sections of this document. Exposure to absolute maximum ratings for extended periods of the time can adversely affect reliability.

^{*2} 4mm from mold body for less than 5 seconds

Electro-Optical Characteristics ($T_a=25^{\circ}\text{C}$, $V_{cc}=3\text{V}$)

Parameter	Symbol	Min.	Typ.	Max.	Unit	Condition
Current consumption	Icc	---	0.4	0.6	mA	No input signal
Supply voltage	V _{CC}	2.7	---	5.5	V	
Peak wavelength	λ_p	---	940	---	nm	
Reception range	L ₀	14	---	---	m	See chapter 'Test method' ^{*3}
	L ₄₅	6	---	---	m	
	ϕ_h	---	±35	---	deg	
Half angle(horizontal)	ϕ_v	---	±35	---	deg	
Half angle(vertical)	T _H	400	---	800	μs	Test signal according to figure 1 ^{*4}
High level pulse width	T _L	400	---	800	μs	
Low level pulse width	V _{OH}	V _{CC} -0.4	---	---	V	I _{SOURCE} ≤ 1μA
High level output voltage	V _{OL}	---	0.2	0.5	V	I _{SINK} ≤ 2mA
Low level output voltage						

^{*3} The ray receiving surface at a vertex and relation to the ray axis in the range of $\theta=0^{\circ}$ and $\theta=45^{\circ}$.

^{*4} A range from 30cm to the arrival distance. Average value of 50 pulses.

业务技术咨询：TEL/微信：13422876592

Test method

The specified electro-optical characteristics are valid under the following conditions.

1. Measurement environment

A place without extreme light reflections.

2. External light

The environment contains an ordinary, white fluorescent lamp without high frequency modulation.

The color temperature is 2856K and the illumination at the IR receiver is less than 10 Lux ($E_v \leq 10\text{Lux}$).

3. Standard transmitter

The test transmitter is calibrated by using the circuit shown in figure 2. The radiation intensity of the transmitter is adjusted until $V_o=400\text{mVp-p}$. Both the test transmitter and the photo diode have the peak wavelength of 940nm. The photo diode for calibration is PD438B ($\lambda_p=940\text{nm}$, $V_r=5\text{V}$).

The color temperature is 2856K and the illumination at the IR receiver is less than 10 Lux ($E_v \leq 10\text{Lux}$).

4. The measurement system is shown in Fig.-3

Fig.-1 Transmitter Wave Form

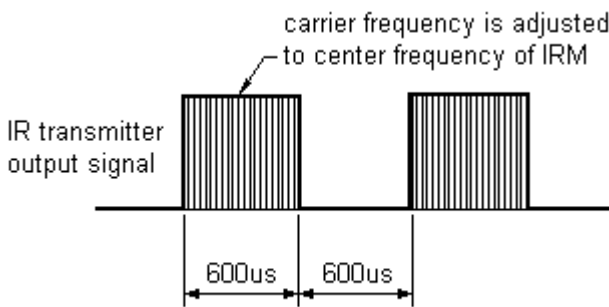

D.U.T output Pulse

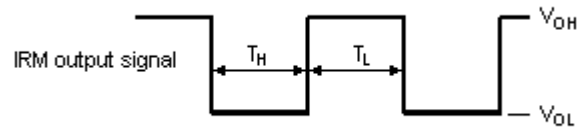

Fig.-2 Standard transmitter calibration

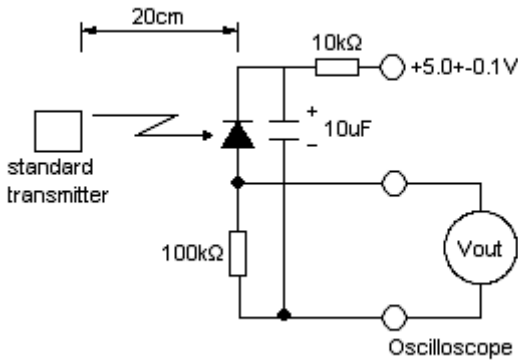
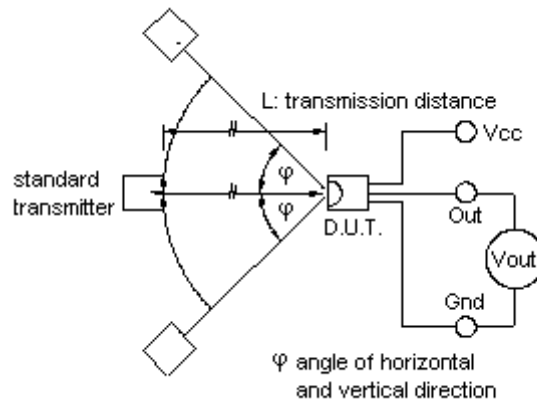

Fig.-3 Measuring System



Typical Electro-Optical Characteristic Curves

Fig.4 Relative Responsibility vs. Wavelength

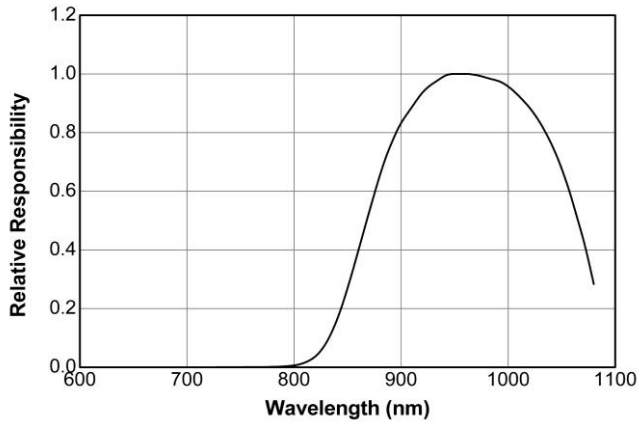

Fig.5 Relative Sensitivity vs. Angle

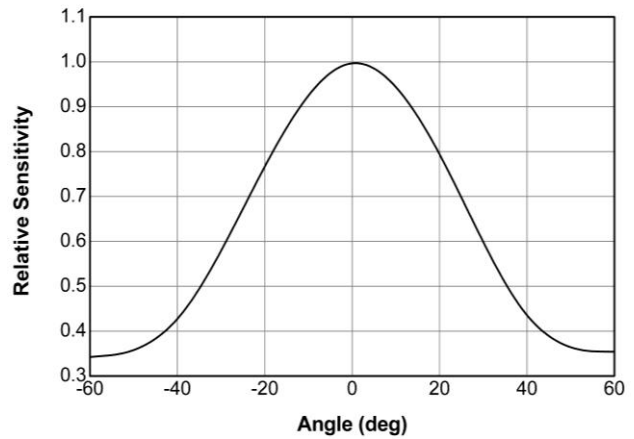

Fig.6 Variation Output Pulse Width vs. Distance

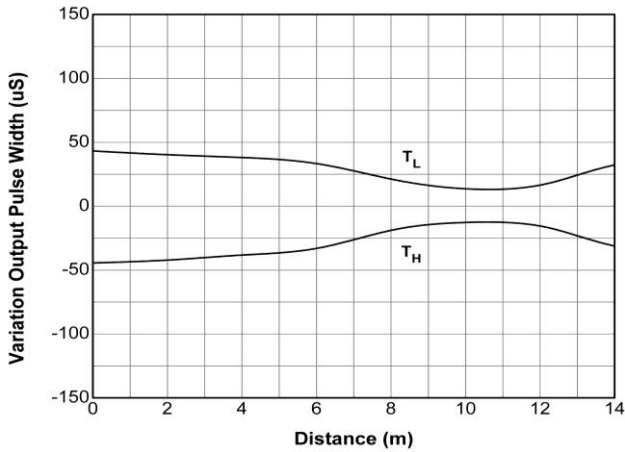

Fig.7 Relative Sensitivity vs. Supply Voltage

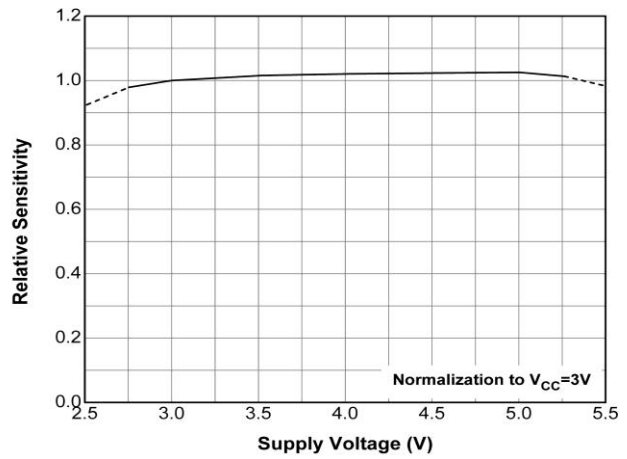
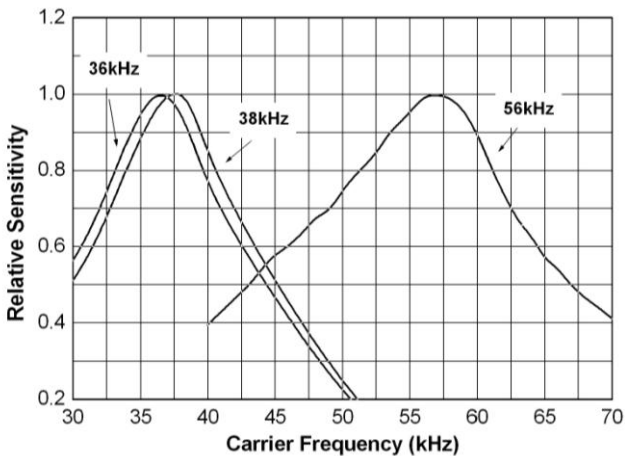

Fig.8 Relative Sensitivity vs. Carrier Frequency



Code information

Protocol	Suitable	Protocol	Suitable
JVC	Yes	Sharp	Yes
Matsushita	Yes	Sony 12 bit ²⁾	Yes
Mitsubishi	No	Sony 15 bit	No
NEC	Yes	Sony 20 bit	No
RC5	Yes	Toshiba	Yes
RC6 ¹⁾	Yes	Continuous Code	No
RCA	No		

1) Best choice depends on RC6 mode. If data low time is below 22ms, M2 is the best choice, otherwise M3.

2) If only Sony 12 bit version is used, M3 is recommended otherwise M2 is the best choice.

Device Marking

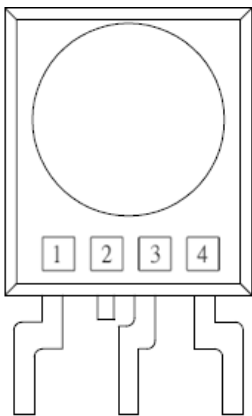

Notes

- 1 denotes Year code
- 2 denotes Month code
- 3 denotes Device number
- 4 denotes Carrier frequency

Packing Quantity

1500 pcs / Box
10 Boxes / Carton

Package Dimensions
(Dimensions in mm)

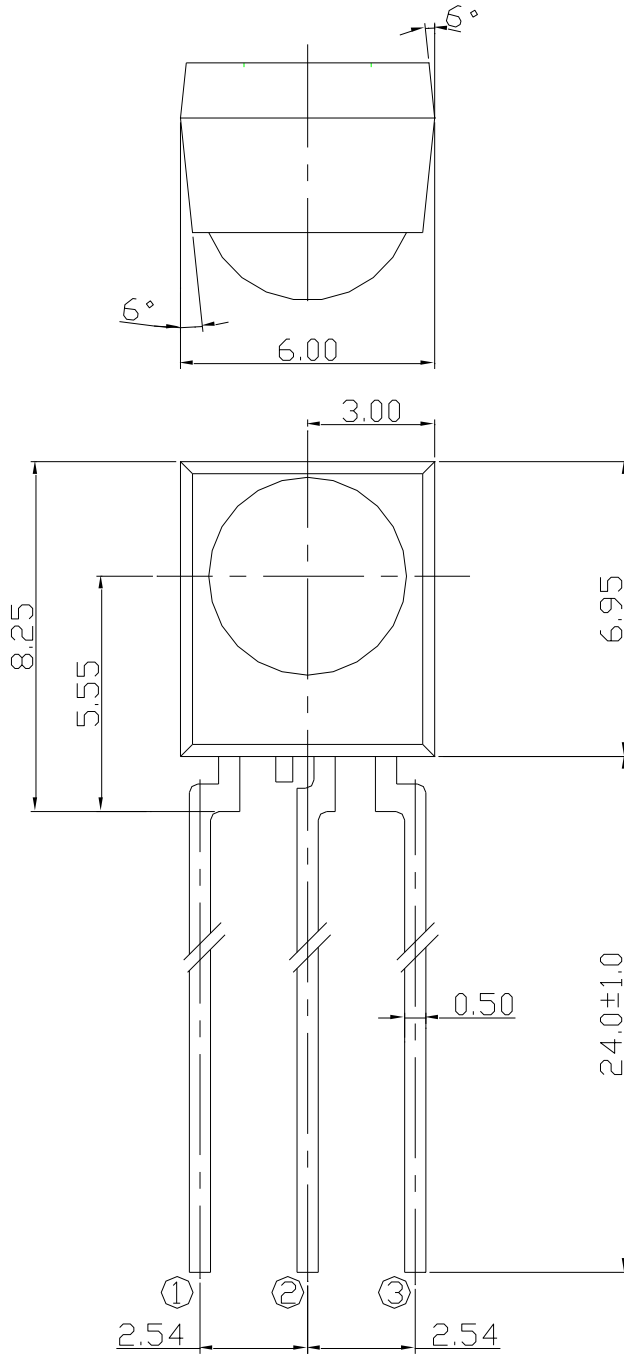

Pin Function

- ① Vout
- ② Vcc
- ③ GND

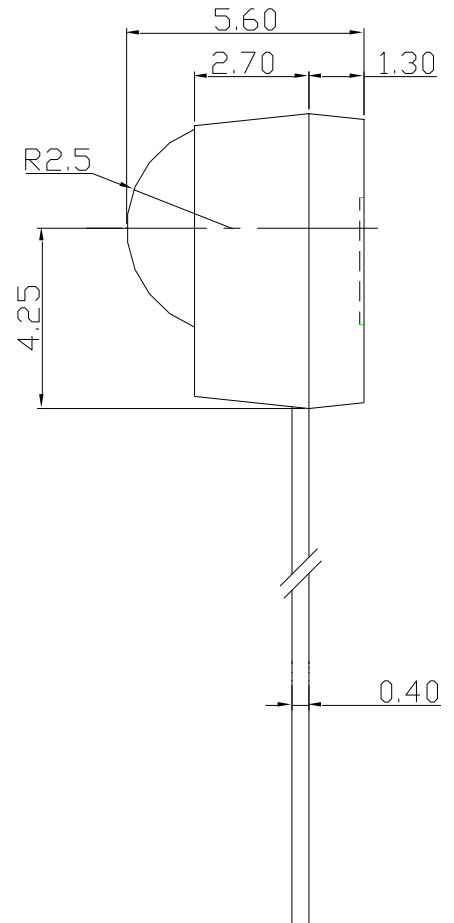

Notes:

- 1. All dimensions are in millimeters.
- 2. Tolerances unless dimensions $\pm 0.5\text{mm}$.

DISCLAIMER

1. EVERLIGHT reserves the right(s) on the adjustment of product material mix for the specification.
2. The product meets EVERLIGHT published specification for a period of twelve (12) months from date of shipment.
3. The graphs shown in this datasheet are representing typical data only and do not show guaranteed values.
4. When using this product, please observe the absolute maximum ratings and the instructions for using outlined in these specification sheets. EVERLIGHT assumes no responsibility for any damage resulting from the use of the product which does not comply with the absolute maximum ratings and the instructions included in these specification sheets.
5. These specification sheets include materials protected under copyright of EVERLIGHT. Reproduction in any form is prohibited without obtaining EVERLIGHT's prior consent.
6. This product is not intended to be used for military, aircraft, automotive, medical, life sustaining or life saving applications or any other application which can result in human injury or death. Please contact authorized Everlight sales agent for special application request.